



## A WIRELESS SENSOR NETWORK FOR POLYHOUSE CULTIVATION USING ZIGBEE TECHNOLOGY

Prathiba Jonnala and G. S. R. Sathyanarayana

Department of Electronics and Communication Engineering, Vignan University Vadlamudi, Andhra Pradesh, India

E-Mail: [jp\\_ece@vignanuniversity.org](mailto:jp_ece@vignanuniversity.org)

### ABSTRACT

The required climatic conditions for the polyhouse cultivation can be provided by using this proposed technique. The Zigbee technology has used for implementing the proposed wireless network. Few of the surrounding parameters of ambient temperature, humidity percentage, light intensity range and soil moisture content inside polyhouse are controlled and optimum conditions for crop growth inside polyhouse can be provided with the proposed model using abrupt actuators used. This model has developed with the mesh topology consists various nodes which are deployed inside polyhouse and are controlled by one central monitoring unit (CMU). Based on the crop the threshold values for the sensors and control values for the actuators during day time and night time are programmed in the CMU and it continuously receives the sensors data from all the nodes, and with respect to the programmed values of crop the CMU sends the controlling data to the actuator node for maintaining constant and required environmental conditions. By using this proposed model the necessity of human effort can be reduced and also the suitable weather conditions for the crop production irrespective of the season can be provided for the maximum beneficiary to the farmer.

**Keywords:** polyhouse cultivation, zigbee module, AT89S52 microcontroller, DHT11, LM35, light intensity sensor, soil moisture sensor.

### 1. INTRODUCTION

India is a country where majority of its population are dependent on agriculture. Agriculture is the broadest economic sector which has major contribution in the development of India. India is also concentrating on the technological aspects. When technology and agriculture are integrated together that may yield good results.

Conventional method of cultivation requires tremendous amount of time, human effort and requires continuous monitoring. There are several problems such as unpredictable weather conditions and the plants may be easily affected by pest and diseases in conventional method of cultivation. A polyhouse is a closed environment where the plants are grown on a controlled platform irrespective of climate and location. Generally polyhouse is a structure built using bamboos or iron pipes which are covered with ultra violet sheet of certain thickness. The thickness of ultra violet sheets depends on the crop variety. Always the direction of the polyhouse is directed from east toward west as it can utilize the maximum amount of sunlight for the photosynthesis process to happen. A polyhouse is a closed structure where the plant can be protected from abnormal climatic condition, pests and diseases. Mainly the plant growth depends up on few parameters like temperature, humidity, co<sub>2</sub> levels, soil moisture content and light intensity. If we are able to control all the above said parameters to which a plant certainly require it, results in proper growth of the plant which in turn results in high yield of the crop by improving the growth potential of the plant and by providing ideal condition for the plant growth. But it is highly impossible to monitor and control all the above said parameters in an open environment. The main idea is to

perform cultivation in a closed environment which is nothing but a polyhouse environment and monitor and control all the required parameters. Any change in one parameter may affect the other climatic parameters, so it requires continuous monitoring and control action for the requirements to meet.

Inadequate and uncertain environmental conditions may affect the proper growth of the plant. Monitoring and controlling of the environmental parameters should be given utmost attention in order to attain high yield. The controlling of these parameters by performing some control action may result in proper plant growth and increased yield. Various papers [1]-[6] have been published claiming the need and advantages about polyhouse cultivation using various technologies. The required data about the existing parameters inside the polyhouse is acquired with the help of respective sensors and is sent to the control unit. The information is transferred to the control unit using wireless technology Zigbee. This data is processed with the help of a microcontroller which decides the control action to be performed in order to maintain optimal environment for the plant growth [3].

This paper mainly concentrates on various climatic parameters that can be monitored and controlled to improve the crop productivity. To monitor these parameters various sensors like temperature sensor to monitor the temperature, Humidity sensor to monitor the air moisture content, Soil moisture sensor to monitor the soil moisture content, light intensity sensor to monitor the amount of light inside the polyhouse are used. The required climatic parameters information can be acquired from the polyhouse environment using these sensors. In order to monitor all the above said parameters require



large number of sensors and wires. The system uses long wires it becomes complex and the installation cost also will go high. The best solution to reduce the complexity and the cost is to use wireless sensor networks. WSN has its own advantages like less cost, size, low power consumption and above all flexibility. Zigbee has carved a niche for itself among the galaxy of wireless technologies. As Zigbee protocol is available with its unique features like low cost and other advantages, it is used widely for agricultural applications. This Zigbee protocol allows the communication between the control unit and the actuator unit in order to monitor and control the environment inside the polyhouse. Zigbee has many advantages over other wireless networking protocols, but it has got its own disadvantages such as batteries need to be replaced on periodic basis [1] and one cannot completely rely on Zigbee for long distance communication. The battery problem can be reduced to some extent by using alkaline batteries.

The proposed hardware architecture, design methodology of mesh topology and the description about temperature, humidity sensor, soil moisture sensor and light intensity sensor has discussed in chapter II of proposed hardware and methodology of polyhouse automation system implementation. The overall process of the proposed system has classified and the classified blocks has explained has presented as a flow chart and explained in the later chapter III. The snapshots of the

final outputs and the designed prototype of proposed system is discussed and shown in chapter IV of results. The chapter V discuss conclusion and its usefulness.

## 2. PROPOSED HARDWARE AND METHODOLOGY OF POLYHOUSE AUTOMATION SYSTEM

### A. Hardware architecture

The entire prototype is divided into two hardware blocks. Those are sensor node and central monitoring system. The hardware designed and placed inside the polyhouse is sensor module which helps in providing optimum environmental conditions inside the polyhouse. Central monitoring system is the monitoring block from which the entire operation can be monitored and controlled using microcontroller through Zigbee network. Attached LCD display connected will provide the information of the environmental parameters existed in the polyhouse.

The hardware block of module 1 as shown in Figure-1 performs three tasks. Firstly, it acquires the data from sensors, secondly processes the data as per instructions and controls the cooling fans and motors, and finally transmits the data to the receivers.

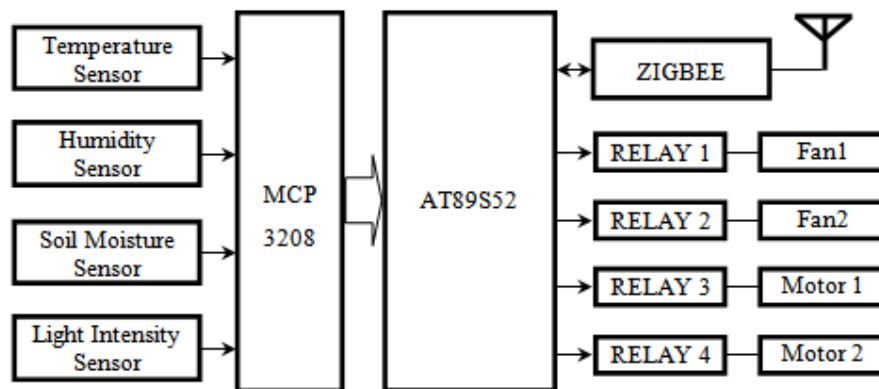


Figure-1. Sensor node.

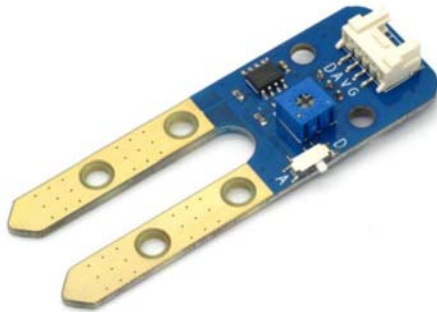
The four sensors LM35, DHT11, soil moisture sensor and light intensity sensor are connected to MCP3208. The analog output from these sensors is converted into digital using eight channels ADC of MCP3208 and the output is directed to the AT89S52 microcontroller. The Microcontroller compares the received values from ADC with the pre-loaded values of temperature, humidity, moisture content of the soil, light intensity levels and the received values from Zigbee, and if the result exceeds stored threshold value, it sends the signals to corresponding relay switches in order to maintain the optimum weather conditions inside

polyhouse. The readings of temperature, humidity, moisture content of the soil, light intensity levels and the status of Fan 1, Fan 2, Motor 1 and Motor 2 is transmitted to the Central monitoring system (CMU). Can use Xbee itself as ADC but has the drawback limited ADC channels, thereby can't provide more number of sensors. To overcome this hurdle, AT89S52 and MCP3208 has used. In similar, by using Xbee can control digital outputs but if need to control more actuators it won't support. The ADC resolution is less in Xbee (8 bit) but needed more resolution for better controllability.





### E. Soil moisture sensor

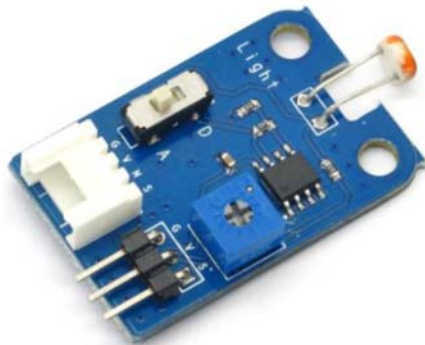


**Figure-6.** Soil moisture sensor [9].

Figure-6 shows the snapshot of the soil moisture sensor and is used to detect the moisture content in the soil of the proposed model. This sensor provides either analog or digital outputs which can be selected by choosing the corresponding button on the board. By varying the potentiometer the suitable threshold value for the moisture content can be made. Analog data provides over wide range and where as digital provides the information about whether the soil is wet or dry.

### F. Light Intensity sensor

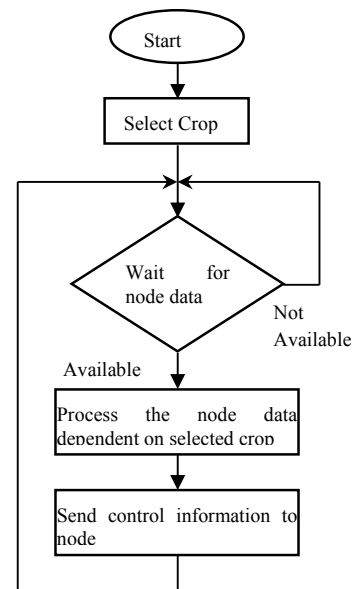
Light detection for the proposed model can be achieved by using the sensor shown in Figure-7. This sensor also provides both the analog and digital outputs. The attached control board receives the analog information about light through the attached light dependent resistor (LDR) and gives the proportionate output, specifically the resistance of photo resistor decreases with the increase of the light intensity in the surroundings.



**Figure-7.** Light intensity sensor.

### 3. FLOW CHART

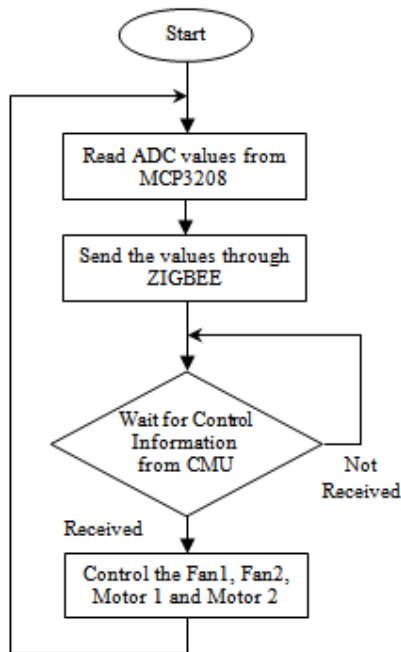
The operation of the proposed system can be described using flow charts as shown in Figure-8 and Figure-9. From the Figure-8. Main CMU unit can be explained as the operation starts from the selection of crop. Based on the crop the threshold values of sensors are fixed. And based on these values the actuators are controlled. Once the crop selection is chosen next step is to wait for the data from nodes. The sensor values from corresponding nodes are processed by the microcontroller unit based on the selection of crop. And with respect to the programmed control parameters of actuators the abrupt information is transmitted to the actuator node.



**Figure-8.** CMU.

The sensor node operation starts from the data reception from the sensors. And this sensors data is transmitted to the CMU using Zigbee Module. Then CMU process the transmitted data from sensor node and sends the controlling information about the operation of actuators Fan1, Fan 2, Motor 1 and Motor 2. Each Node is assigned with the unique ID for each Zigbee module and based on this Zigbee ID only all the nodes are communicated with the CMU.

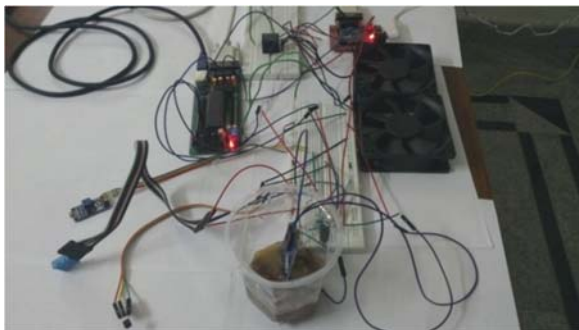




**Figure-9.** Sensor node.

#### 4. RESULTS

Figure-10 shows the main sensor node. And from the Figure-10 can observe the four different sensors, different actuator units, Zigbee module and microcontroller startup kit considered for the implementation of the proposed model. For testing the prototype different environmental parameters have applied to sensor node manually.



**Figure-10.** Sensor node of the poly house.

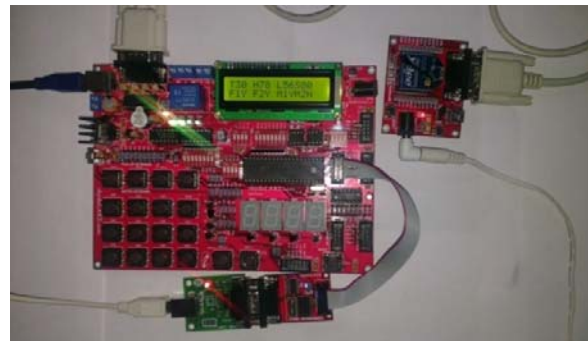
Figure-11 shows CMU and its received values of sensors from Zigbee module on its LCD screen. The LCD screen has the 16x2 characters provision and the sensors values are displayed on the first row and its actuators status of ON or OFF are shown in the second row. The received values of ambient temperature, humidity level, light intensity range and soil moisture sensor values are shown as in degree centigrade and percentage levels. And the actuators of Fan 1, Fan 2, Motor 1 and Motor 2 status

are shown as ON and OFF levels. From the Figure-11 the user interface buttons can be observed and using these buttons the values for the actuators can be fixed based on the requirement of the environmental parameters needed for the polyhouse.



**Figure-11.** PC node with values 1.

Figure-12 shows the different values received by the CMU. The polyhouse needs different climatic conditions for day time and night time for the same crop. In order to test the status of actuators for the different values of climatic parameters of sensors have applied different climatic conditions.



**Figure-12.** PC node with values 2.

The snapshots of Figure-11 have taken at 22°C and Figure-12 is taken at 30°C, followed by different values of humidity, light intensity and soil moisture content. The status of actuators are given as Y for ON and N for OFF which can be observed from the second row of the LCD screen from the Figure-11 as well as in Figure-12.

#### 5. CONCLUSIONS

The wireless sensor network has developed using Zigbee technology for the crop production inside polyhouse. And using this proposed model the requirement of human surveillance can be reduced and increased crop yield by making suitable environment for the crop growth throughout the year irrespective of season



can be achieved. The embedded systems have its own cost and the research has to be done for the economical devices.

## REFERENCES

- [1] Mirabella O.; Brischetto M. 2011. A Hybrid Wired/Wireless Networking Infrastructure for Greenhouse Management. Instrumentation and Measurement, IEEE Transactions on. 60(2): 398-407.
- [2] Prathiba Jonnala. 2013. A Survey on Poly House Cultivation Using Wireless Sensor Networks. International Conference on Navigational Systems and Signal Processing Applications (NSSP-2013), 13th-14th December. pp. 113-116.
- [3] Prathiba Jonnala, Sk. Sadulla. 2013. Wireless Solution for Polyhouse Cultivation Using Embedded System. IEEE International Conference on Renewable Energy and Sustainable Energy (ICRESE-13), 5<sup>th</sup>-6<sup>th</sup> December. pp. 565-569.
- [4] Prathiba Jonnala, Sivaji Satrasupalli. 2013. Semi-automated Polyhouse Cultivation using LabVIEW. International Journal of Computer Science and Business Informatics (IJCSBI). 7(1): 1-13.
- [5] Pekoslawski B. *et al.* 2013. Autonomous wireless sensor network for greenhouse environmental conditions monitoring. Mixed Design of Integrated Circuits and Systems (MIXDES), 2013 Proceedings of the 20th International Conference. pp. 503-507, 20-22 June.
- [6] Peng Li, Yunjie Wu. 2012. A wireless data acquisition system designed for greenhouse based on ZigBee. Intelligent Control and Automation (WCICA), 2012 10th World Congress on. pp. 4405-4408.
- [7] Temperature sensor, LM35 Datasheet, available online: [www.ti.com/lit/gpn/lm35](http://www.ti.com/lit/gpn/lm35).
- [8] Humidity sensor, DHT11 Datasheet, available online: [www.micro4you.com/files/sensor/DHT11.pdf](http://www.micro4you.com/files/sensor/DHT11.pdf).
- [9] Soil Moisture sensor, IM121017001 Datasheet, available online: [ftp://imall.iteadstudio.com/Electronic\\_Brick/IM121017001/DS\\_IM121017001.pdf](ftp://imall.iteadstudio.com/Electronic_Brick/IM121017001/DS_IM121017001.pdf).
- [10] Light intensity sensor, IM120710017 Datasheet, available online: [ftp://imall.iteadstudio.com/Electronic\\_Brick/IM120710017/DS\\_IM120710017.pdf](ftp://imall.iteadstudio.com/Electronic_Brick/IM120710017/DS_IM120710017.pdf).
- [11] Dargie W. and Poellabauer. 2010. Fundamental of Wireless Sensor Networks: Theory and practice. John Wiley and Sons. pp. 168-183.
- [12] AT89S52 Datasheet, available online: [www.atmel.in/Images/doc1919.pdf](http://www.atmel.in/Images/doc1919.pdf).
- [13] Richard Barnett, Larry O'Cull and Sarah Cox. 2007. Embedded C Programming and Atmel AVR. Delmar-Cengage Learning India Pvt. Ltd., Edition (India).